

THE PROPERTY OF THE DRAWING IS ESTABLISHED BY LAW. IT IS FORBIDDEN TO PRODUCE OR SHOW IT TO THIRD PARTY, WITHOUT A WRITTEN AGREEMENT.

Item	Name	Q.ty
1	R.6.SCH	1
2	STF.75.01	1
3	V.TCE6x22	1

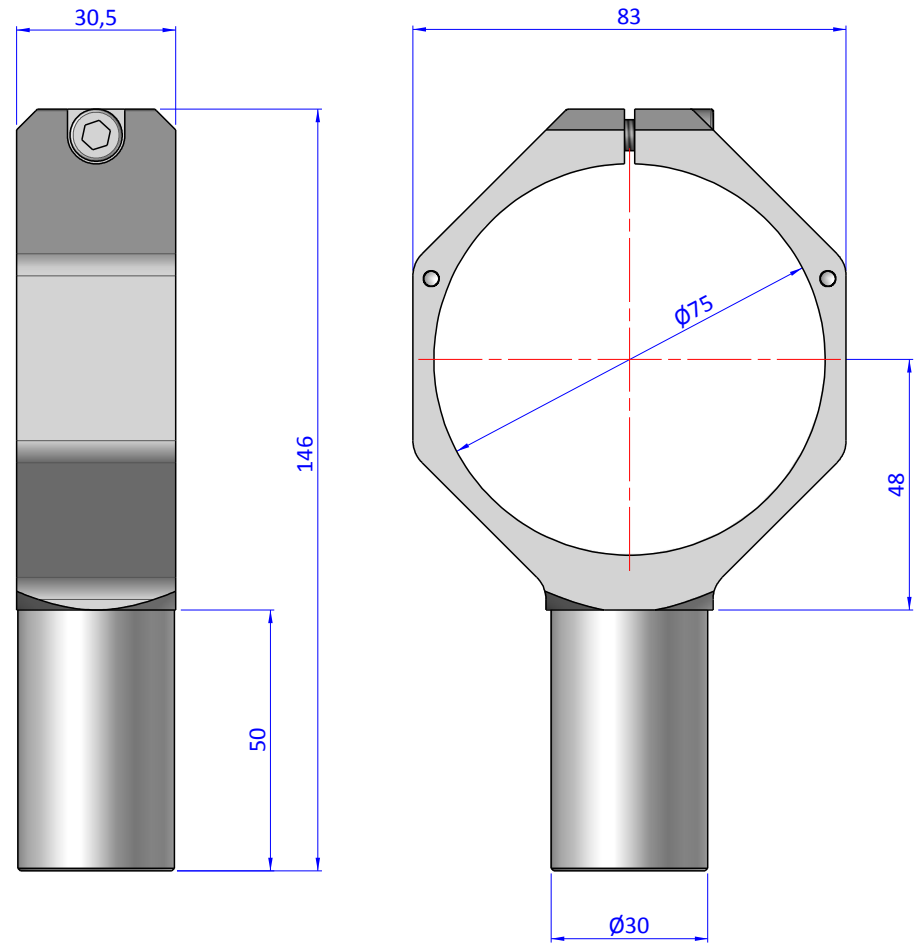
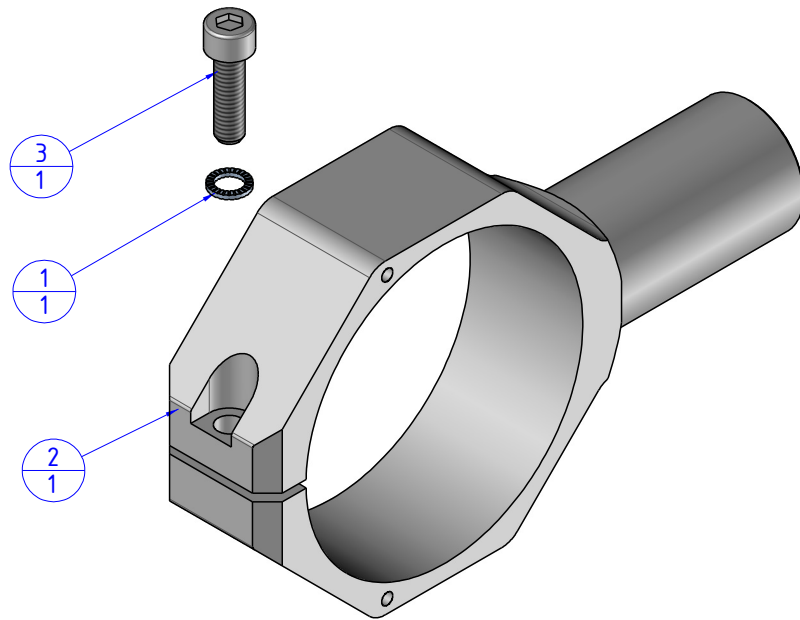

Format A3

UNI 936-76

		DESIGNED FROM		REVIEW
		FPS Automation		A
GENERAL TOLERANCE		DATE	WEIGHT	
UNI - ISO 2768		15/05/2019	0,237kg	
CLASSE f	DESCRIPTION	CODE		
	CA.STF.75	CA.STF.75		